

# Anglo-Chinese School (Junior)



**SEMESTRAL ASSESSMENT (2022)**

**PRIMARY 5**

**SCIENCE**

**BOOKLET A**

**Friday**

**28 October 2022**

**1 hr 45 min**

Name: \_\_\_\_\_ ( ) Class: 5.( )

## **INSTRUCTIONS TO PUPILS**

- 1 Do not turn over the pages until you are told to do so.
- 2 Follow all instructions carefully.
- 3 There are 28 questions in this booklet.
- 4 Answer ALL questions.
- 5 Shade your answers in the Optical Answer Sheet (OAS) provided.

---

**This question paper consists of 20 printed pages (inclusive of cover page).**

For each question from 1 to 28, four options are given. One of them is the correct answer. Make your choice (1, 2, 3 or 4). Shade your answer on the Optical Answer Sheet.

(56 marks)

1. Which statement is correct about yeast?

- (1) It is a type of bacteria.
- (2) It is used to make bread.
- (3) It can make its own food.
- (4) It is not a microorganism.

2. Study the flowchart.

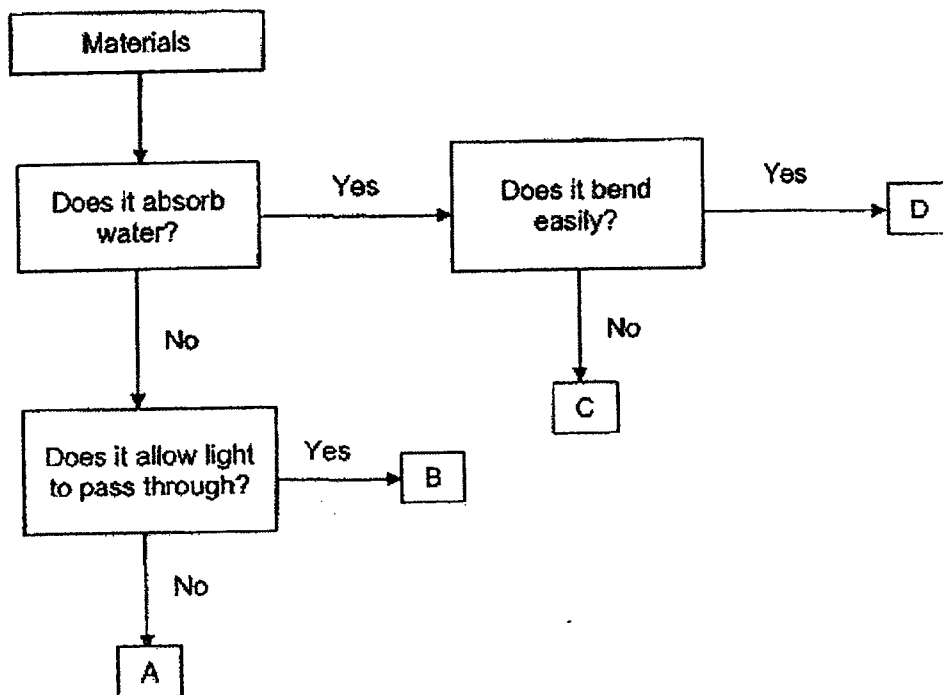

Which material, A, B, C or D, is most suitable to make part X of the sunglasses as shown?



- (1) A
- (2) B
- (3) C
- (4) D

3. Study the life cycles of animals J and K.

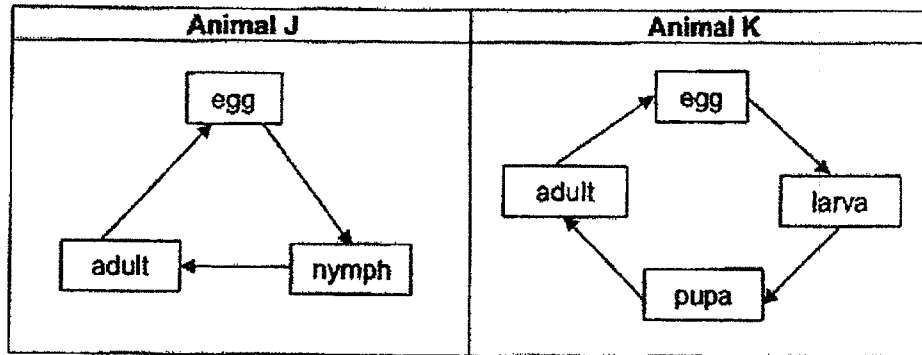

Which two statements are true?

- A The larva of animal K eats a lot.
- B Animal J could be a grasshopper.
- C Animal K's young resembles its adult.
- D Both life cycles of animals J and K begin with the egg stage.

- (1) A and B
- (2) A and D
- (3) B and C
- (4) C and D

4. Aneesa placed five identical green bean seeds each into four identical containers, A, B, C and D. She placed the containers at different locations as shown and watered the seeds daily for three days.

Container	Location
A	Garden
B	Freezer
C	Dark Cupboard
D	On the kitchen table

In which container(s) will the seeds germinate over the next few days?

- (1) B only
- (2) A and D only
- (3) B and C only
- (4) A, C and D only

5. The diagram shows the seed dispersal patterns of plants A, B and C.

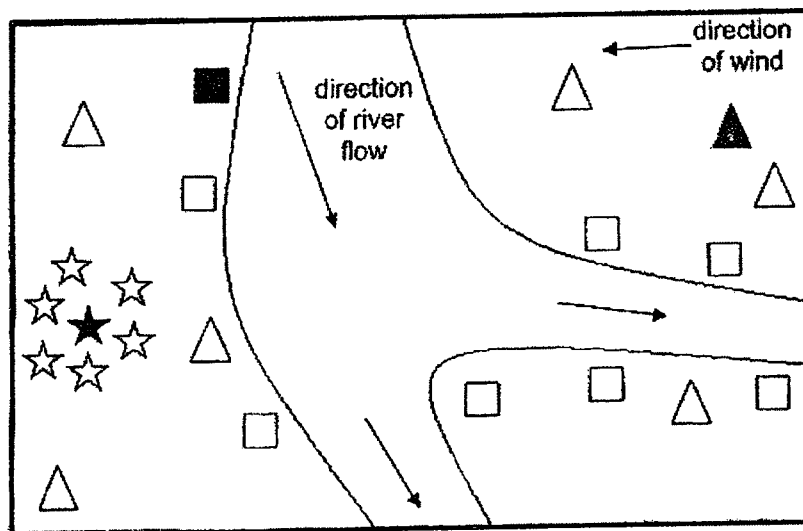

Key :

■ Parent plant A	□ Young plant of A
★ Parent plant B	☆ Young plant of B
▲ Parent plant C	△ Young plant of C

Which of the following characteristics do the fruits/seeds of plants A, B and C have?

	Plant A	Plant B	Plant C
(1)	pod	hooks	wing-like structure
(2)	fibrous husk	pod	hooks
(3)	hooks	wing-like structure	fibrous husk
(4)	wing-like structure	fibrous husk	pod

6. The diagram shows the cross-section of a flower and fruit from plant X.

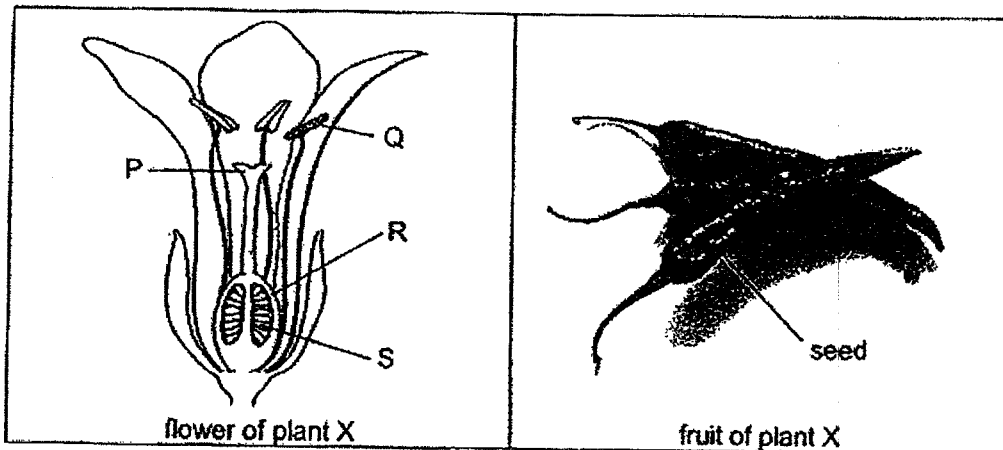

Which parts of the flower did the seed and fruit develop from?

	Seed	Fruit
(1)	P	Q
(2)	Q	P
(3)	R	S
(4)	S	R

7. The diagram shows the parts of the human female reproductive system. A cut was made at X.

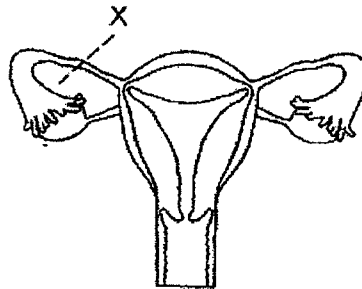

Which of the following statement(s) is/are true?



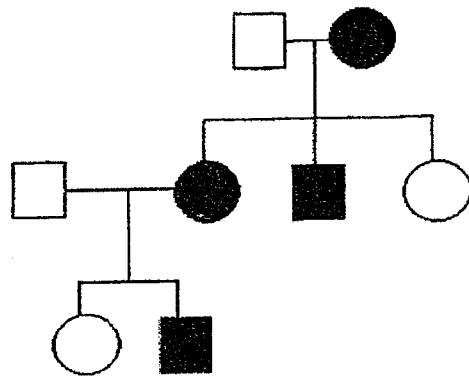

- A Eggs will not be released.
  - B Fertilization can take place.
  - C Sperms can enter the vagina.
  - D The foetus will not be able to develop.
- (1) D only  
 (2) B and C only  
 (3) C and D only  
 (4) A, B and C only

8. Study the family tree.



Xueling

Key :

	male with double eyelids
	male with single eyelid
	female with double eyelids
	female with single eyelids

Which is statement about Xueling is true?

- (1) Her aunt has single eyelids.
- (2) Her father has double eyelids.
- (3) Her brother has single eyelids.
- (4) Her grandfather has double eyelids.

9. The diagram shows the water cycle with processes A and B.

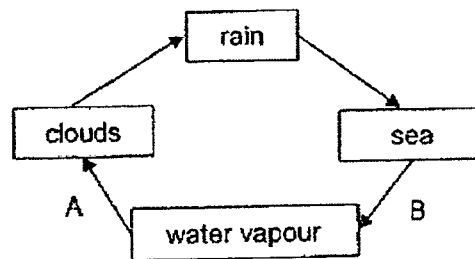

Which statement about process A or B is correct?

- (1) Water loses heat during process A.
- (2) Water gains heat during process B.
- (3) Process B takes place at a fixed temperature.
- (4) There is no change in the state of matter during process A.

10. Shariq filled identical containers Q, R and S, with 50 ml of water each and covered them with different lids as shown. He left the containers at the Science lab and measured the volume of water left in each container after three hours.

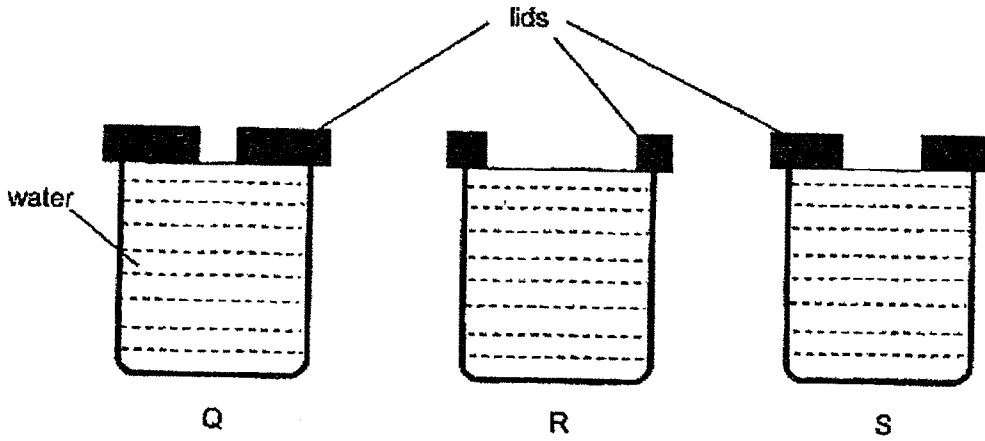

Which of the following graph shows the correct volumes of water left in containers Q, R and S, after three hours?

(1) Volume of water left (ml)

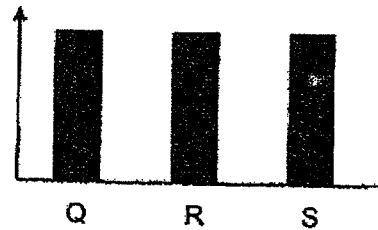

(2) Volume of water left (ml)

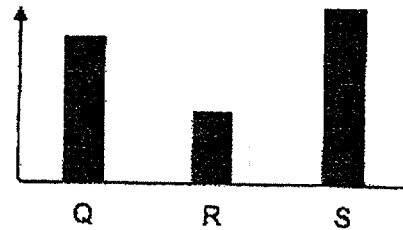

(3) Volume of water left (ml)



(4) Volume of water left (ml)

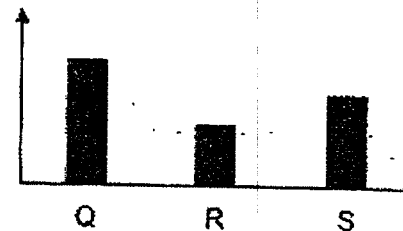

11. The diagram shows the arrangement of five magnets.

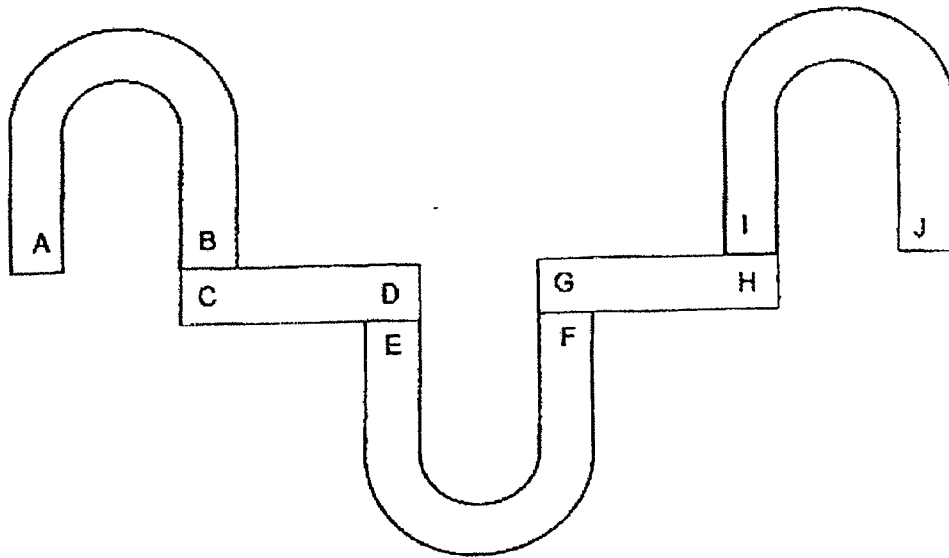

Which of the following arrangements is not possible?

(1)

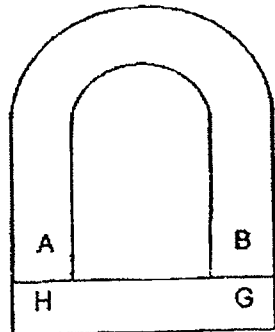

(2)

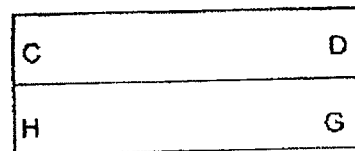

(3)

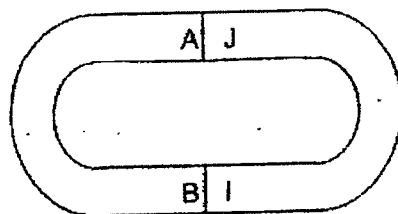

(4)

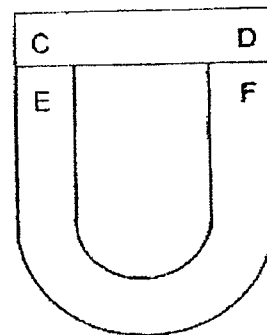



12. Adam used the stroke method to make the iron nail into a temporary magnet as shown. He then placed the temporary magnet near some steel clips. Only one steel clip was attracted to the temporary magnet.

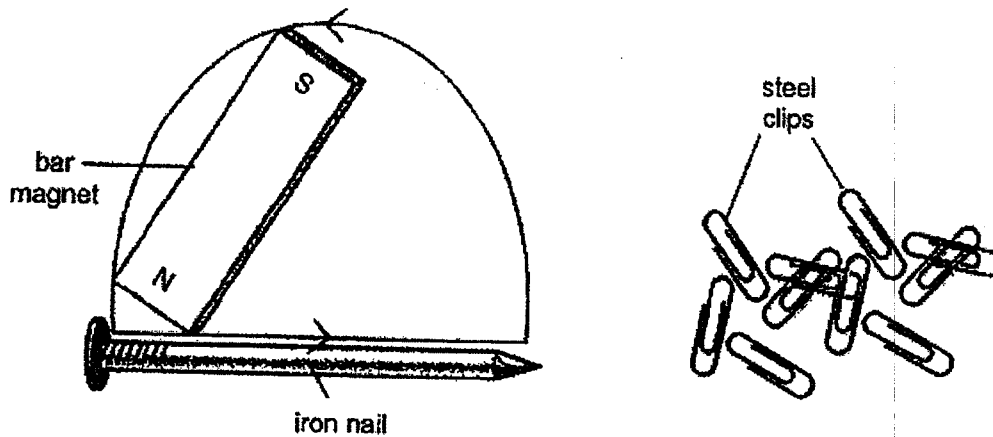

What should she do to the temporary magnet so that it can attract more steel clips?

- A Put it over a flame.
  - B Drop it from a height.
  - C Bring it nearer to the steel clips.
  - D Stroke it more times using the North pole of the bar magnet in the same direction.
- (1) C only  
 (2) C and D only  
 (3) A and B only  
 (4) A, B and D only

13. Peter labelled one end of objects J, K, L and M as X. He brought each end of a magnet towards end X of all four objects.

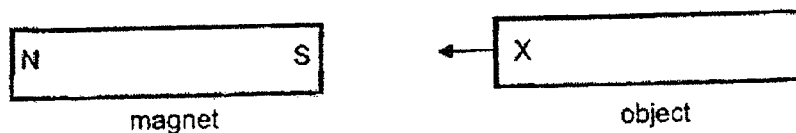

He recorded the interactions in the table as shown.

Object	When North pole of the magnet was brought near end X	When South pole of the magnet was brought near end X
J	Attracted	Attracted
K	No interaction	No interaction
L	Attracted	Repelled
M	Repelled	Attracted

Which of the following statement(s) is/are correct?

- A Object J is made of aluminium.
- B Objects J, L and M are magnets.
- C Object K is made of a non-magnetic material.

- (1) C only
- (2) A and B only
- (3) A and C only
- (4) A, B and C

14. Which parts of the body are correctly matched to the human organ systems?

	Digestive system	Respiratory system	Skeletal system
(1)	mouth	heart	skull
(2)	stomach	lungs	muscles
(3)	blood vessels	nose	ribcage
(4)	large intestine	windpipe	backbone

15. The diagram shows a plant.

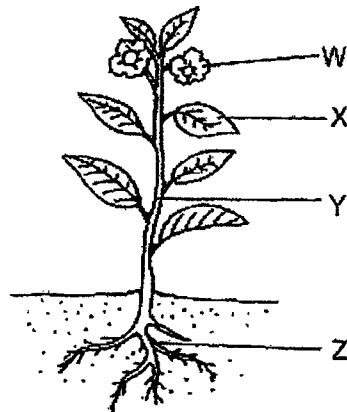

Which statement(s) is/are correct?

- A Part X makes food.
- B Part W contains seeds.
- C Part Y holds the plant upright.
- D Part Z takes in water and mineral salts.

- (1) A only
- (2) B and C only
- (3) A, C and D only
- (4) B, C and D only

16. The diagram shows the movement of food and water in a plant.

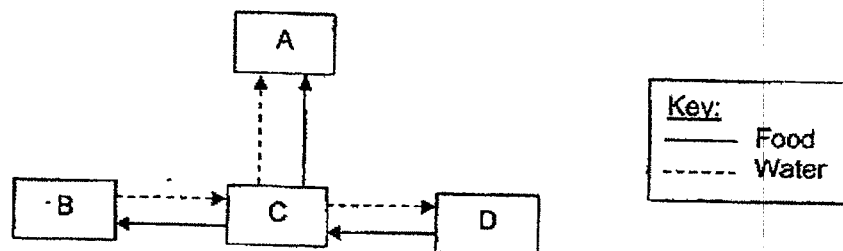

What are parts A, B, C and D?

	A	B	C	D
(1)	Fruit	Roots	Stem	Leaves
(2)	Roots	Stem	Leaves	Fruit
(3)	Fruit	Leaves	Stem	Roots
(4)	Leaves	Stem	Roots	Fruit

17. A potted plant was placed in a glass container and left in the garden. The amount of carbon dioxide in the glass container was measured and recorded over 24 hours in the graph as shown.

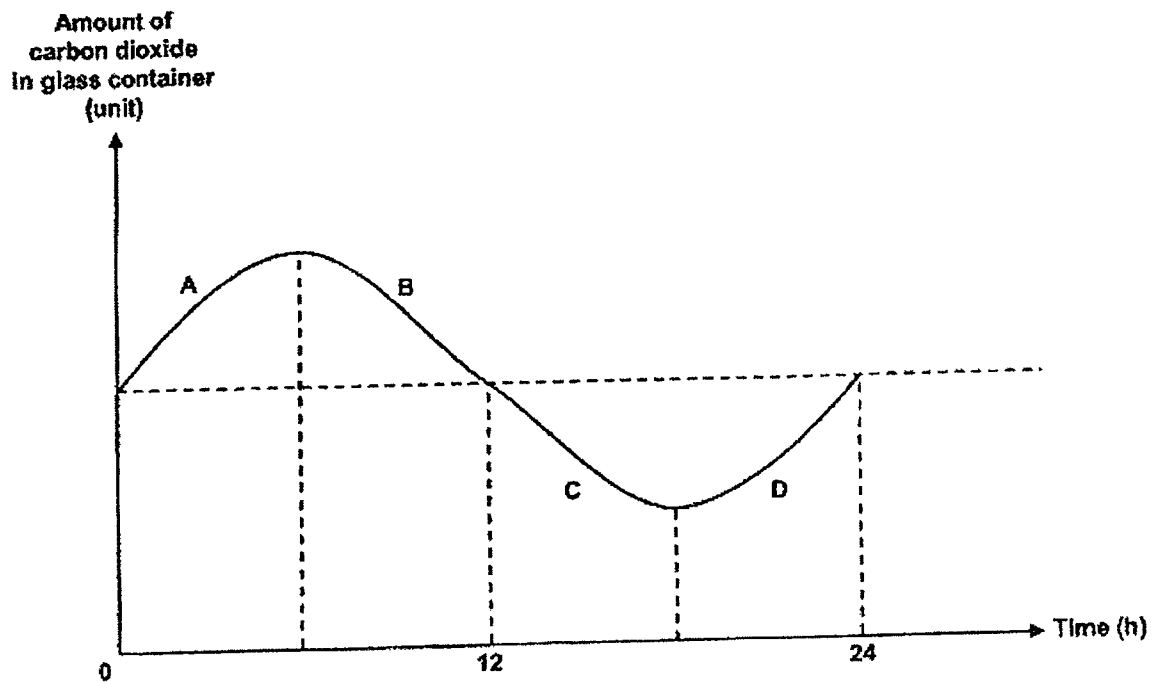

Which two parts of the graph show that the plant was carrying out photosynthesis?

- (1) A and B
- (2) B and C
- (3) C and D
- (4) A and D

18. The diagram shows the flow of blood in the human body. X and Y represent organs in the human body while P, Q, R, S, T and U represent the blood vessels in the body.

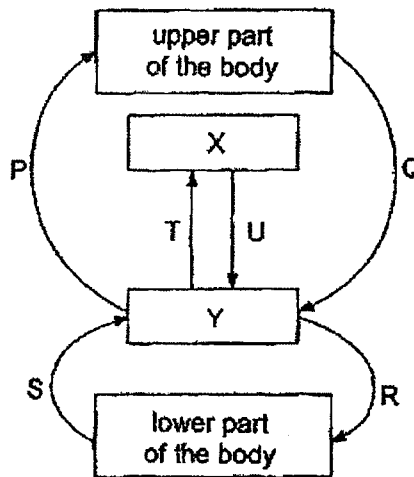

Which of the following correctly represents organs X and Y and describes the amount of oxygen and carbon dioxide in the blood of the blood vessels?

	X	Y	Blood rich in oxygen	Blood rich in carbon dioxide
(1)	Lungs	Heart	P, R and T	Q, S and U
(2)	Heart	Lungs	P, S and T	Q, R and U
(3)	Lungs	Heart	P, R and U	Q, S and T
(4)	Heart	Lungs	Q, R and U	P, S and T

19. The table lists some information about four cell parts.

Which of the following is correct?

	Cell part	Function of cell part	Present in animal cell?	Present in plant cell?
(1)	Cytoplasm	Controls the movement of substances in and out of the cell.	Yes	Yes
(2)	Chloroplast	Contains chlorophyll which traps light to make food.	No	Yes
(3)	Cell Membrane	Allows the movement of substances within the cell.	Yes	No
(4)	Cell Wall	Protects the cell and gives it a fixed shape.	Yes	Yes

20. Circuits P, Q, R and S are set up using identical batteries and bulbs, which are in working condition.

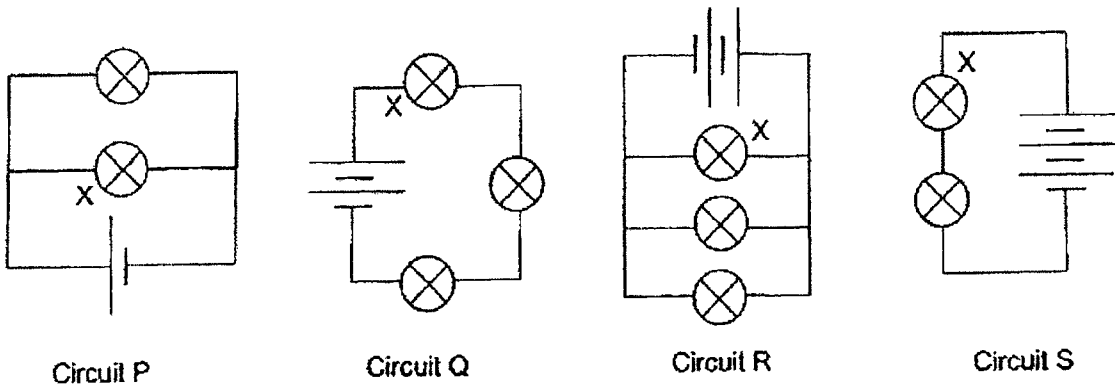

Which of the following shows the correct order of the brightness of bulb X in each circuit, from the dimmest to the brightest?

- (1) S, R, Q, P
  - (2) Q, P, S, R
  - (3) P, Q, R, S
  - (4) R, S, P, Q
21. Ari used a syringe to pump  $100 \text{ cm}^3$  of air into a container with a volume of  $250 \text{ cm}^3$ .

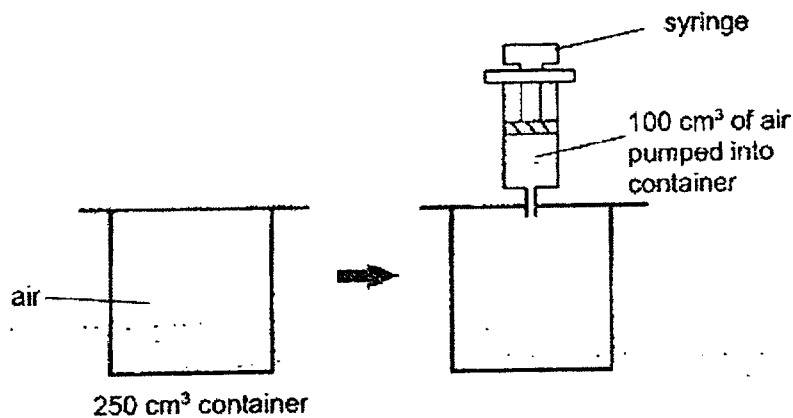

After  $100 \text{ cm}^3$  of air was pumped in, which of the following about the mass and volume of air in the container is correct?

	Mass of air in container	Volume of air in container
(1)	increased	increased
(2)	increased	remained the same
(3)	remained the same	increased
(4)	remained the same	remained the same

22. Anna used a circuit tester to test a circuit card. She connected points X and Y of the circuit tester to the metal pins A, B, C, D and E on the circuit card and observed if the bulb would light up.

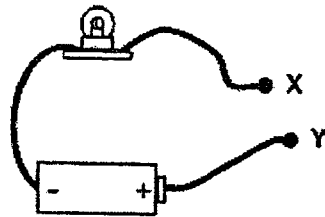

circuit tester

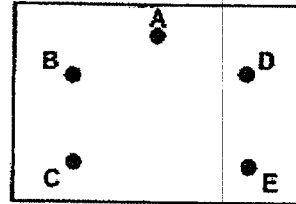

circuit card

She recorded the results in the table.

Metal pins connected	Did the bulb light up?
A and B	No
A and C	Yes
C and D	Yes
D and E	No

Which circuit card did Anna test?

(1)

(2)

(3)

(4)

23. Jeffri sets up two circuits using similar electrical components in working condition and four objects, A, B, C and D, as shown.

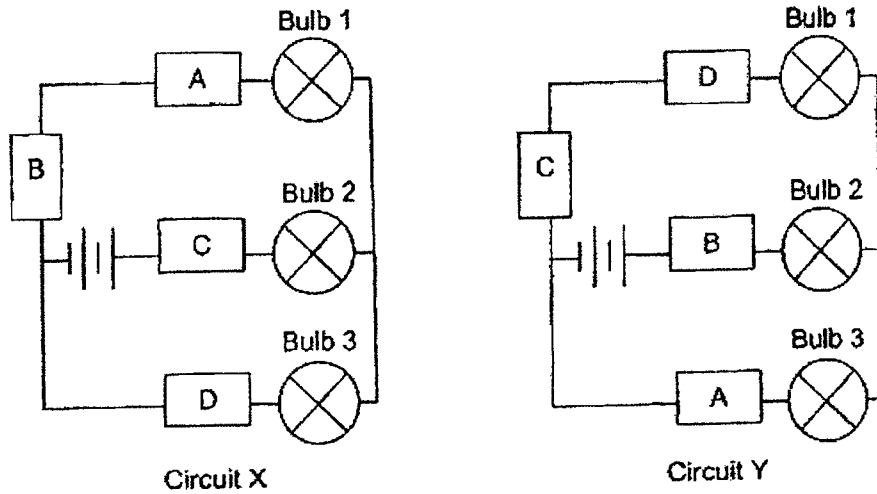

The table shows the results of his experiment.

	Did the bulbs light up?		
	Bulb 1	Bulb 2	Bulb 3
Circuit X	No	No	No
Circuit Y	No	Yes	Yes

Which one of the following is correct?

	Conductors of electricity	Non-conductors of electricity	Not possible to tell
(1)	A	B	C and D
(2)	A	None	B, C and D
(3)	A and B	C and D	None
(4)	A and B	C	D



24. The diagram shows a man walking down a street from lamp A to lamp D. Of the four street lamps along the street, only one was lighted up. The street lamps were the same distance apart from each other.

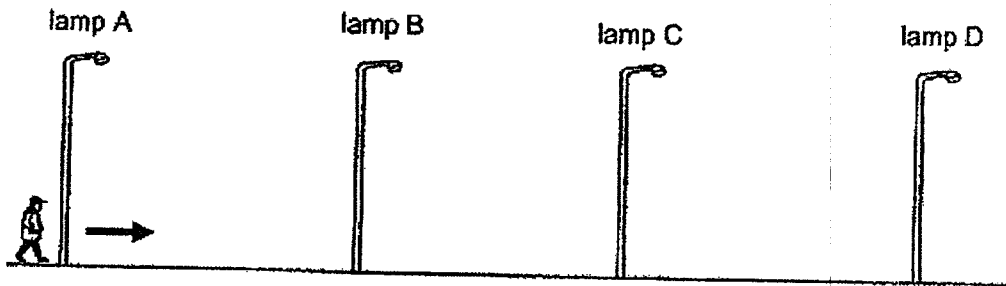

The graph shows how the length of his shadow changes as he walked from lamp A to lamp D.

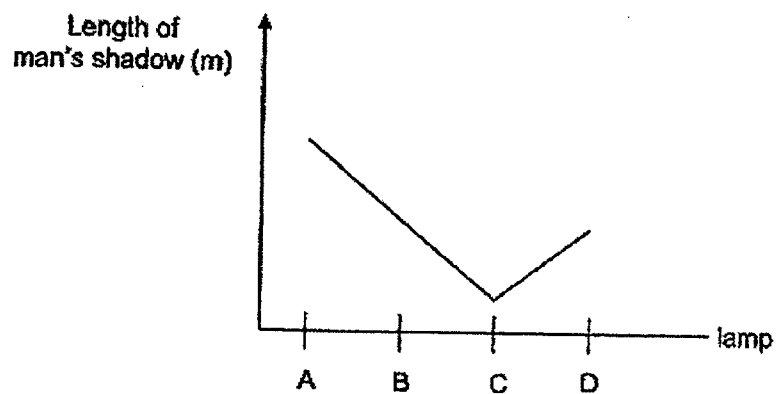

Based on the graph, which street lamp, A, B, C, or D, was lighted up?

- (1) A
- (2) B
- (3) C
- (4) D

25. Ryan set up an experiment using three identical beakers, each containing a different liquid as shown. The volume of liquid in each beaker and the intensity of light from the torches are the same.

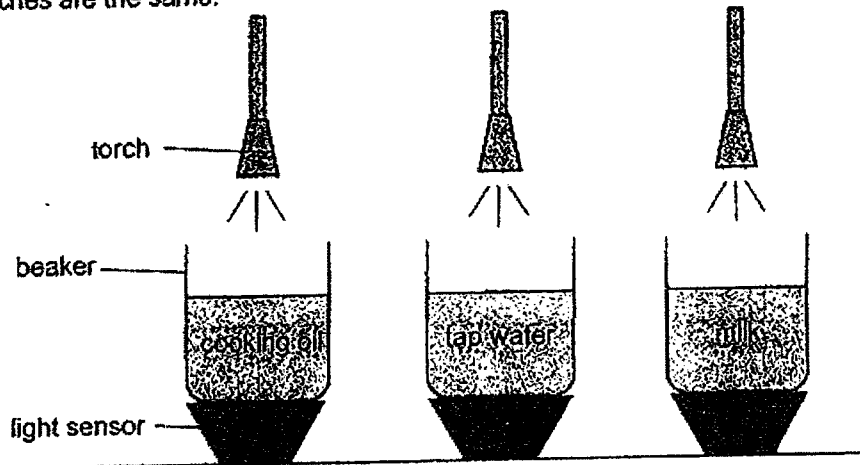

He used identical light sensors, X, Y and Z, to measure the amount of light that passed through each beaker of liquid and recorded the readings.

Which is the most likely reading from the light sensors?

Units of light			
	X	Y	Z
(1)	0	200	100
(2)	200	100	0
(3)	0	100	200
(4)	100	200	0

26. Susie poured herself a glass of water. She then added some ice cubes and a metal spoon to the glass of water as shown.

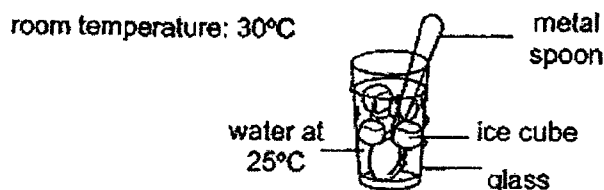

Which two statements are incorrect?

- A The glass loses heat to ice cubes.
- B The ice cubes gain heat from the water.
- C The water loses heat to the surrounding air.
- D The metal spoon gains heat from the ice cubes.

- (1) A and B
- (2) B and C
- (3) C and D
- (4) A and D

27. An experiment was carried out using the two identical set-ups with different volumes of water as shown. The Bunsen burners were turned on at the same time to heat the water in the beakers until the water reached 100°C.

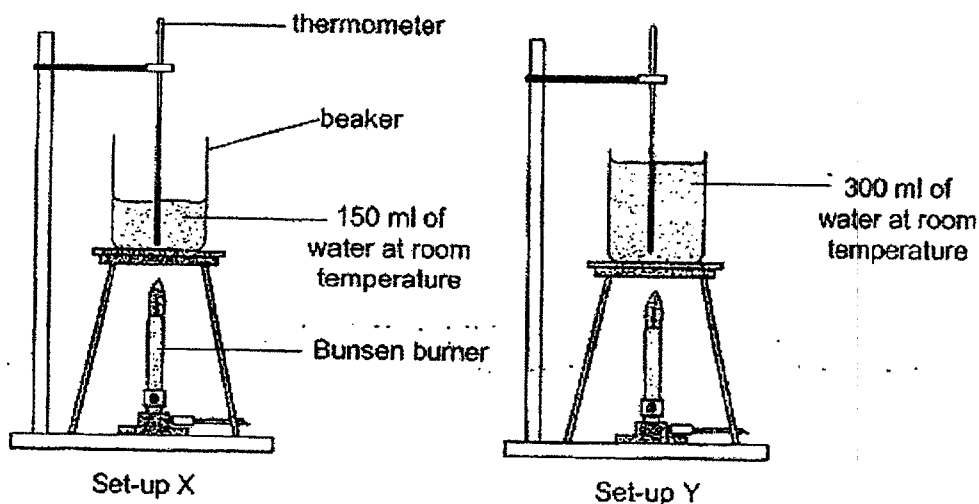

Which statement is correct?

- (1) Water in both set-ups have the same amount of heat.
- (2) Water in both set-ups reached 100°C at the same time.
- (3) Water in Set-up X has more heat than the water in Set-up Y.
- (4) Water in Set-up X will reach 100°C faster than the water in Set-up Y.

28. The diagram shows a leaf of a plant partially covered with black paper on both sides of the leaf.

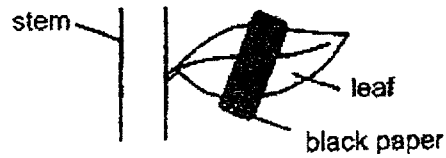

The plant was then placed in an area with plenty of sunlight and given sufficient water daily. After five days, the same leaf was tested for starch using iodine solution. Iodine solution changes from brown to blue-black in the presence of starch.

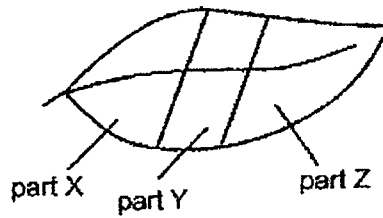

Which part(s) of the leaf would the iodine solution remain brown?

- (1) Part X only
- (2) Part Y only
- (3) Parts X and Z only
- (4) Parts X, Y and Z only

End of Booklet A

# Anglo-Chinese School (Junior)



## SEMESTRAL ASSESSMENT (2022)

PRIMARY 5

SCIENCE

BOOKLET B

Friday

28 October 2022

1 hr 45 min

Name: \_\_\_\_\_ ( ) Class: 5.( ) Parent's Signature: \_\_\_\_\_

### INSTRUCTIONS TO PUPILS

- 1 Do not turn over the pages until you are told to do so.
- 2 Follow all instructions carefully.
- 3 Answer ALL questions.
- 4 Use a dark blue or black ballpoint pen to write your answers in the space provided for each question.
- 5 Do not use correction fluid/tape or highlighters.
- 6 The marks are given in the brackets [ ] at the end of each question or part question.

Booklet	Possible Marks	Marks Obtained
A	56	
B	44	
Total	100	

This question paper consists of 17 printed pages (inclusive of cover page).

For questions 29 to 41, write your answers in this booklet.

The number of marks available is shown in brackets [ ] at the end of each question or part question.

(44 marks)

29. Falisha placed  $200 \text{ cm}^3$  of sand into beaker A and poured in  $200 \text{ cm}^3$  of water as shown.

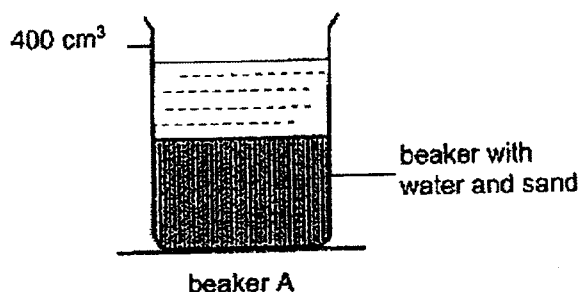

- (a) State the property of water that allowed it to be poured into beaker A. [1]

She repeated the experiment by placing  $200 \text{ cm}^3$  of marbles and  $200 \text{ cm}^3$  of water into beaker B as shown.

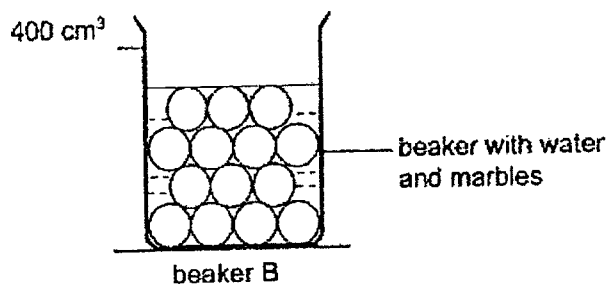

- (b) She noticed that the water level in beaker B is lower than that of beaker A. Explain why. [2]

(Go on to the next page)

SCORE	3
-------	---

30. Devi conducted an experiment and prepared three identical fruits, A, B and C, with different numbers of structure X.



She dropped each fruit from the same height,  $h$ , in front of a fan as shown. She measured the distance,  $d$ , travelled by each fruit.

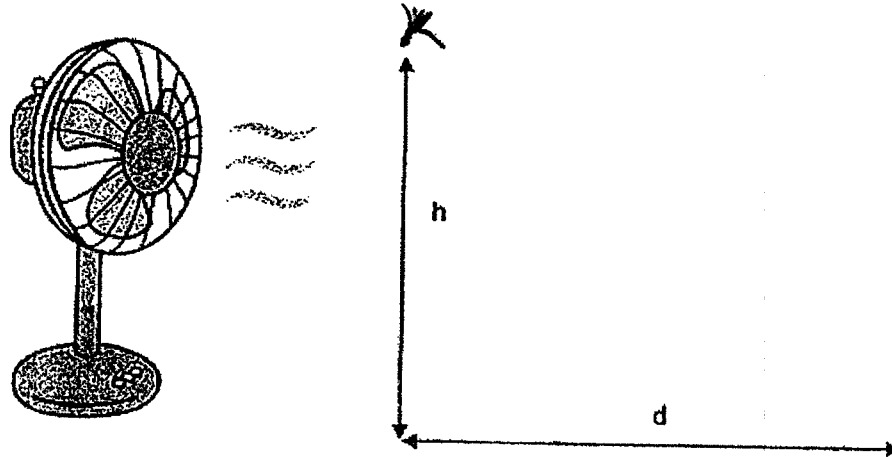

She recorded her results in the table shown.

Fruit	Number of structure X on the fruit	Distance ( $d$ ) travelled by the fruit (cm)
A	5	137
B	3	72
C	1	15

- (a) What is the aim of Devi's experiment? [1]

---



---

- (b) State an advantage to the young plant when the fruit travels a further distance from the parent plant. [1]

---



---

(Go on to the next page)

SCORE	2
-------	---

- (c) Devi then wanted to find out how the speed of wind affects the distance the fruit travelled.

Identify the variables that should be kept the same to test this new aim. Place a tick (✓) in the correct boxes in the table.

[1]

Variables		Keep the same
(i)	Type of fruit	
(ii)	Wind speed	
(iii)	Number of structure X	
(iv)	Height that the fruit is dropped	

(Go on to the next page)

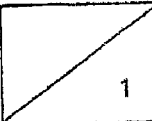
SCORE	
-------	---



31. (a) Describe the process of pollination in flowering plants. [1]
- 
- 

The diagram shows parts A, B and C of the male reproductive system. Part C connects parts A and B where sperms can travel through.

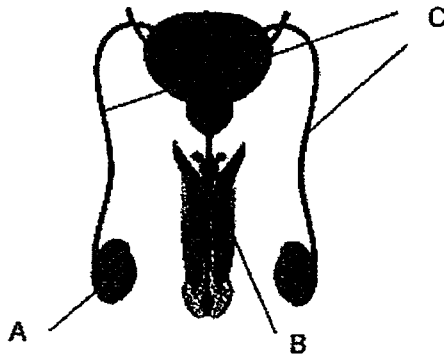

- (b) Which part of the male reproductive system, A, B or C, has the same function as the anther in a flowering plant? [1]
- 

To prevent reproduction from taking place, adult males go through a medical surgery where part C is cut and tied as shown.

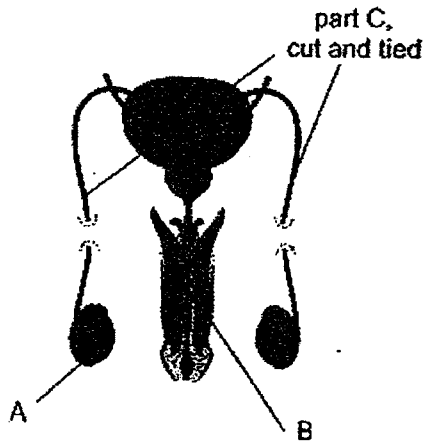

- (c) Give a reason why reproduction cannot take place after part C has been cut and tied. [1]
- 
- 

(Go on to the next page)

SCORE	3
-------	---

32. (a) State one difference between boiling and evaporation of a liquid. [1]

---



---

Nirdesh heated a beaker of seawater at  $27^{\circ}\text{C}$ . As the water started boiling, he placed a tin tray at  $18^{\circ}\text{C}$  above the beaker of water as shown in the diagram.

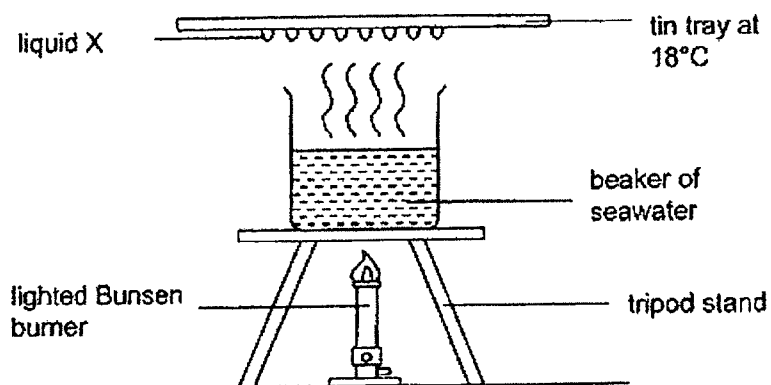

- (b) Nirdesh noticed liquid X forming on the underside of the tin tray. What is liquid X? [1]

---

- (c) Without increasing the heat from the Bunsen burner, suggest what Nirdesh can do so that liquid X forms at a faster rate on the underside of the tray. [1]

---



---



---

(Go on to the next page)

SCORE	3
-------	---

33. Hannah placed some ice cubes in a plastic cup. After five minutes, she noticed that the ice cubes were still melting.



- (a) Name the state(s) of matter present in the cup at the fifth minute. [1]

After two hours, Hannah observed that the ice cubes have completely melted.

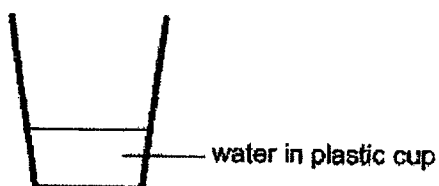

- (b) Without removing the water from the plastic cup, suggest what Hannah could have done so that there will be less water in the cup at the end of two hours. Explain your answer. [2]

Suggestion: \_\_\_\_\_

Explanation: \_\_\_\_\_

(Go on to the next page)

SCORE	
	3

Whilst visiting Switzerland during winter, Hannah noticed that a white 'mist' formed whenever she exhaled.



(c) Explain clearly how the white 'mist' was formed when Hannah exhaled. [2]

---

---

---

(Go on to the next page)

SCORE	
	2

34. Chloe sets up two electromagnets using identical batteries in working condition, wires and iron bars, P and Q, as shown. A steel nail is freely suspended at an equal distance between electromagnets X and Y.

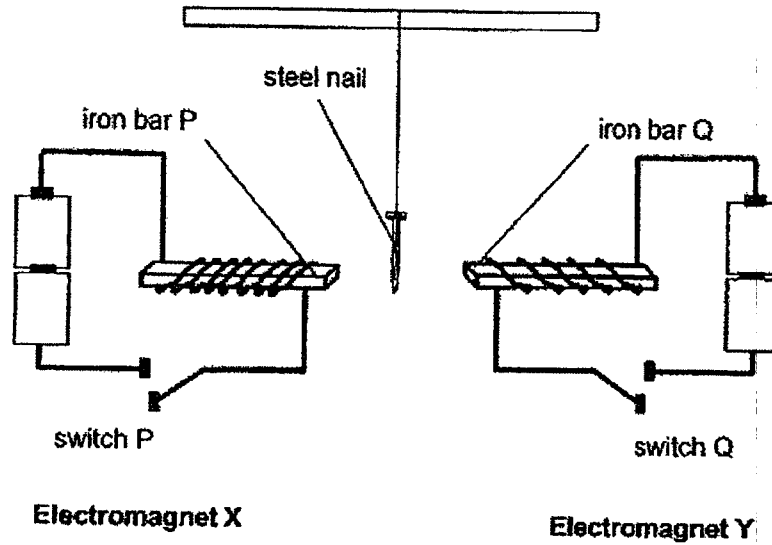

When Chloe closed both switches, P and Q, at the same time, the steel nail moved towards iron bar P.

- (a) Give a reason why the steel nail moved towards iron bar P when both switches P and Q were closed at the same time. [1]

---



---

(Go on to the next page)

SCORE	1
-------	---

The diagram shows part of a crane that uses an electromagnet to collect metal pieces for recycling.

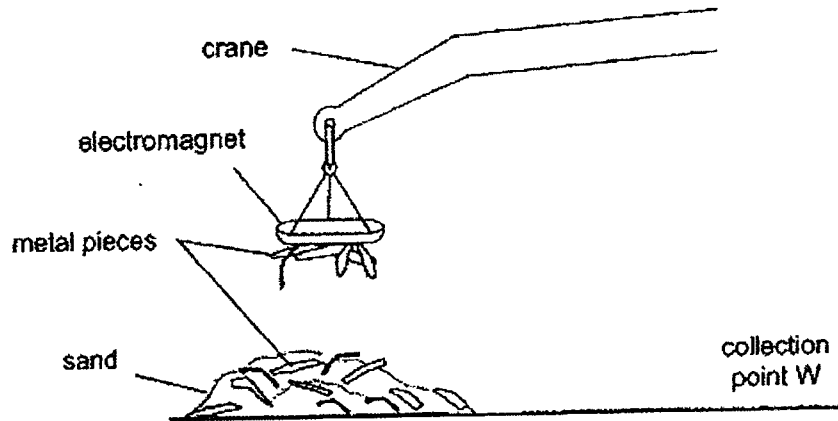

(b) Explain how the electromagnet of the crane is used to move the metal pieces in the sand to the collection point W in the diagram above. [2]

---

---

---

(Go on to the next page)

SCORE	/
	2

35. (a) State what digestion is.

[1]

---



---

The diagram shows the human digestive system.

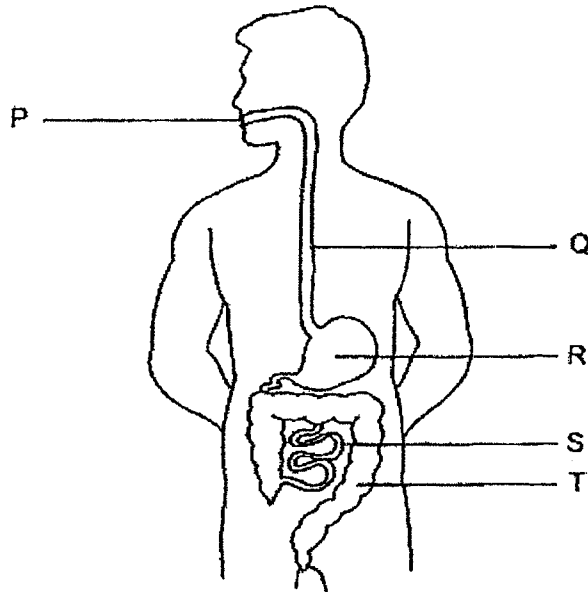

(b) State the part(s) which carry out the following functions by writing the letters P, Q, R, S or T in the boxes provided. [1]

	Function	Part(s)
(i)	Produces digestive juice	
(ii)	Absorbs water from undigested food	

(c) Describe what happens to digested food at part S. [1]

---



---



---

(Go on to the next page)

SCORE	3
-------	---

36. The diagrams show the respiratory systems of a human and a fish.

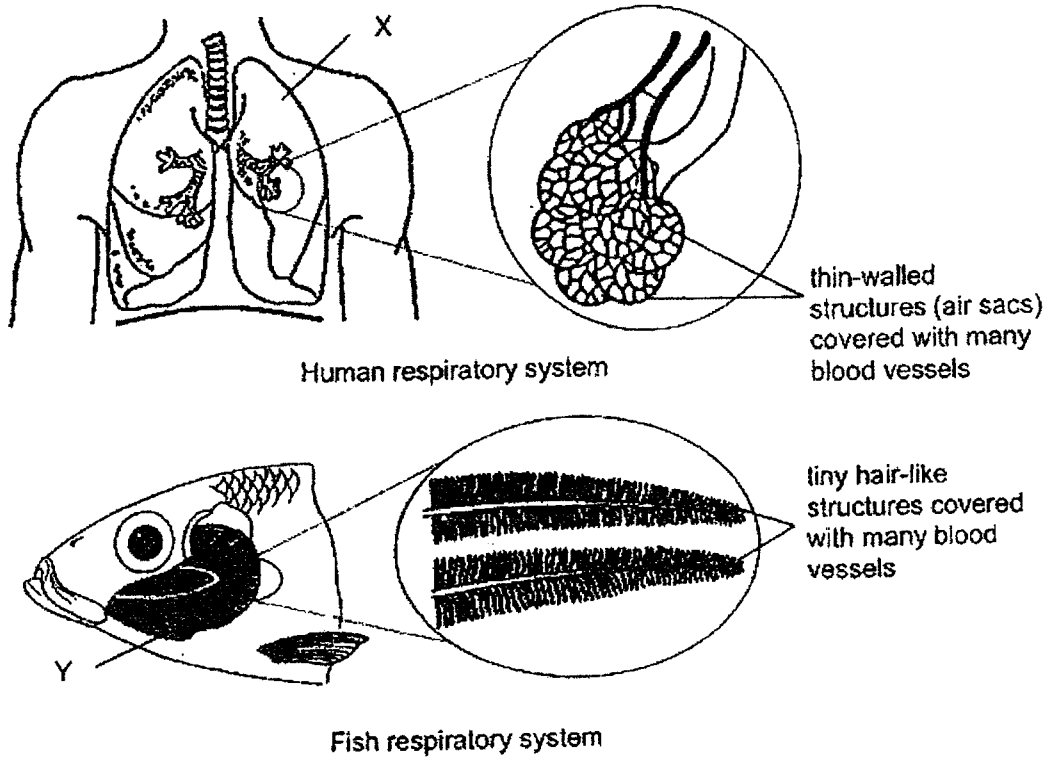

(a) Name organs X and Y of the human and fish respiratory system. [1]

X: \_\_\_\_\_

Y: \_\_\_\_\_

(b) State how the structures covered with many blood vessels in the human and fish respiratory system help in the absorption of oxygen. [1]

\_\_\_\_\_

(c) Describe how oxygen in the environment reaches the blood vessels of the human respiratory system. [1]

\_\_\_\_\_  
\_\_\_\_\_

(Go on to the next page)

SCORE	3
-------	---



37. Jack's resting heart rate is 60 beats per minute. The graph shows the changes in Jack's heart rate as he runs faster on the treadmill.

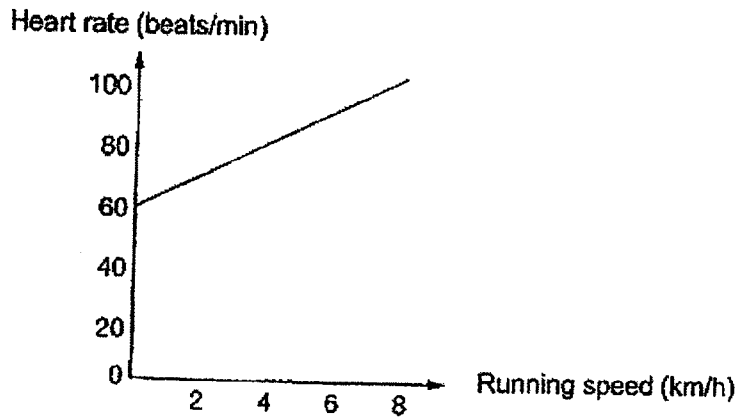

- (a) Explain why Jack's heart rate increases as his running speed increases. [2]

---



---



---

- (b) After running for five minutes, Jack stopped running and sat down to rest for ten minutes. Complete the line graph below to show the changes in Jack's heart rate for the next 10 minutes after he stopped running. [1]

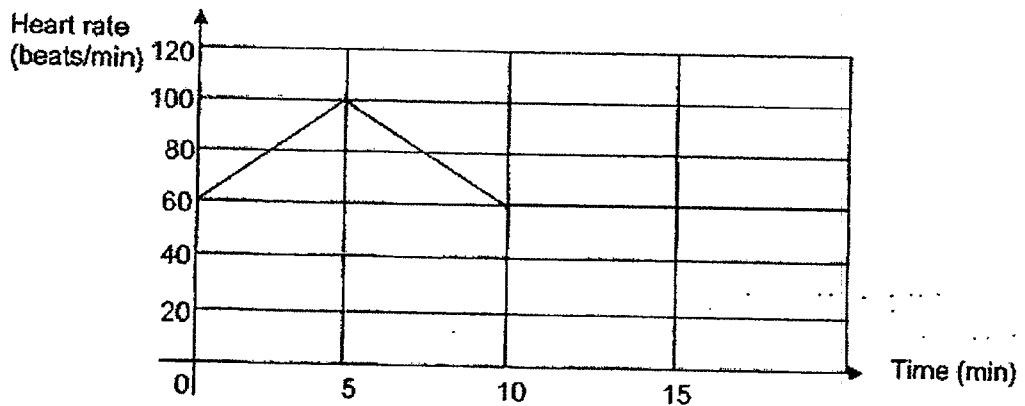

(Go on to the next page)

SCORE	3
-------	---

38. The diagram shows a closed circuit. The bulbs and batteries used are in working condition.

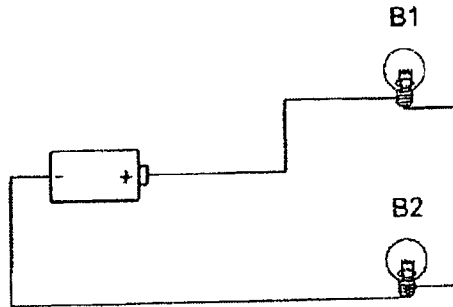

- (a) How are the bulbs B1 and B2 arranged? [1]

---

- (b) State one disadvantage of the arrangement of bulbs in (a). [1]

---

- (c) Using the same electrical parts and an **additional switch**, draw a closed circuit diagram based on the following conditions:

- B1 remains lit all the time
  - B2 is controlled by the switch
- [2]

Label bulbs, B1 and B2, in your circuit diagram.

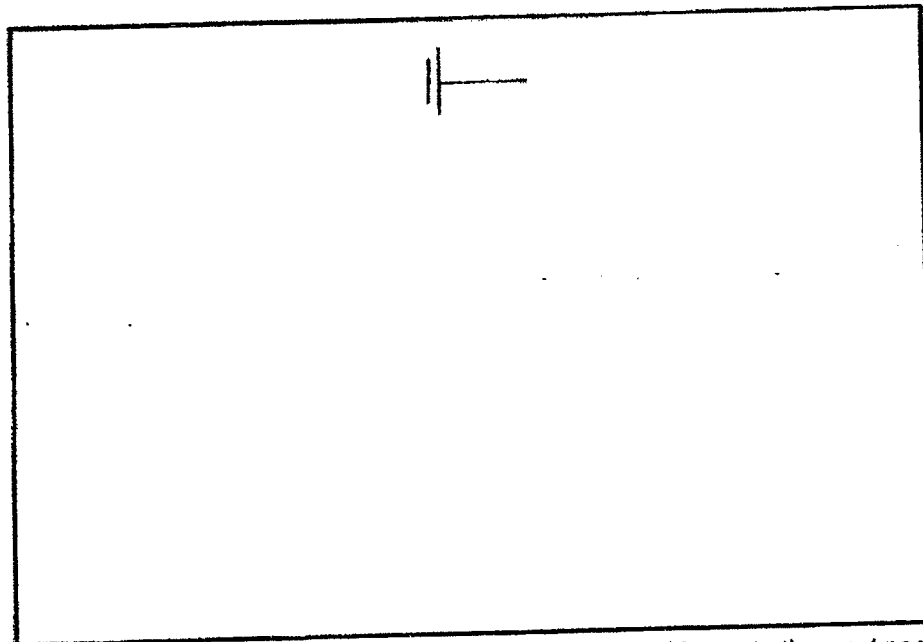

(Go on to the next page)

SCORE	4
-------	---

39. Jack made a simple periscope using a cardboard box and two small mirrors as shown. The periscope allows him to see the cockatoo while remaining hidden.

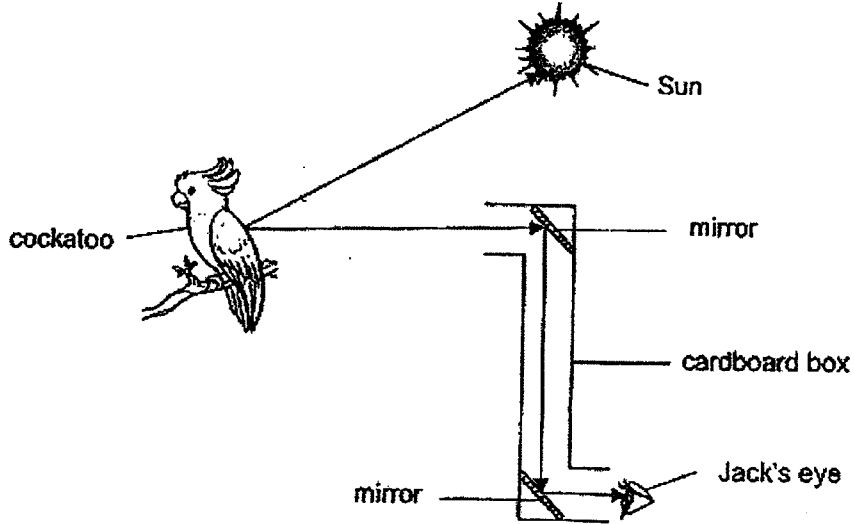

- (a) Jack drew arrows to represent light rays that enable him to see the cockatoo on the diagram. However, he drew one of the arrows wrongly. Circle the arrow which has been drawn wrongly. [1]

- (b) State two properties of light that allow Jack's periscope to work. [2]

Property 1: \_\_\_\_\_  
 \_\_\_\_\_

Property 2: \_\_\_\_\_  
 \_\_\_\_\_

- (c) Jack's classmate, Tessa, told him that light is not matter. Give two reasons why Tessa said so. [1]

Reason 1: \_\_\_\_\_  
 \_\_\_\_\_

Reason 2: \_\_\_\_\_  
 \_\_\_\_\_

(Go on to the next page)

SCORE	4
-------	---

40. Tom prepared three set-ups, A, B and C, with three identical metal bottles containing equal volumes of cold water at 5°C as shown. Set-ups B and C were covered with material X and material Y.

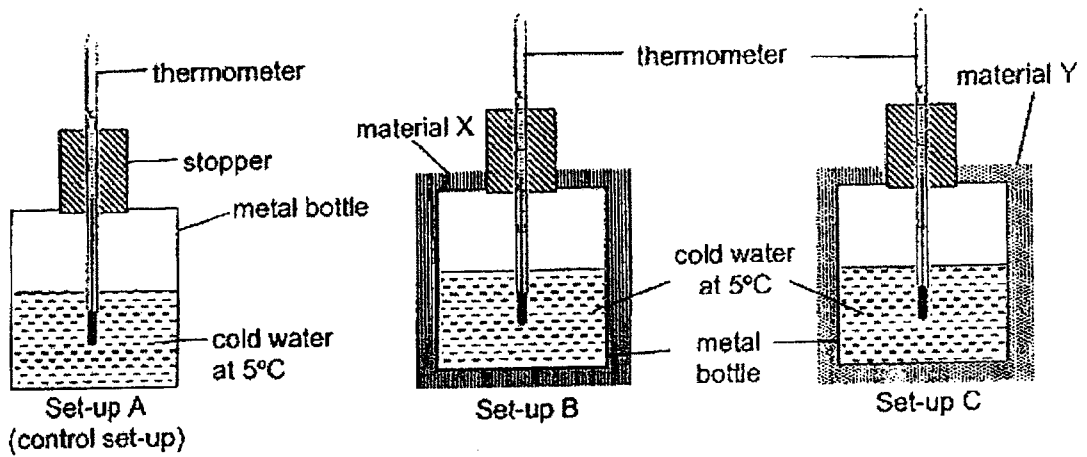

Tom recorded the temperature of the water in set-ups B and C over eight hours in the graph as shown.

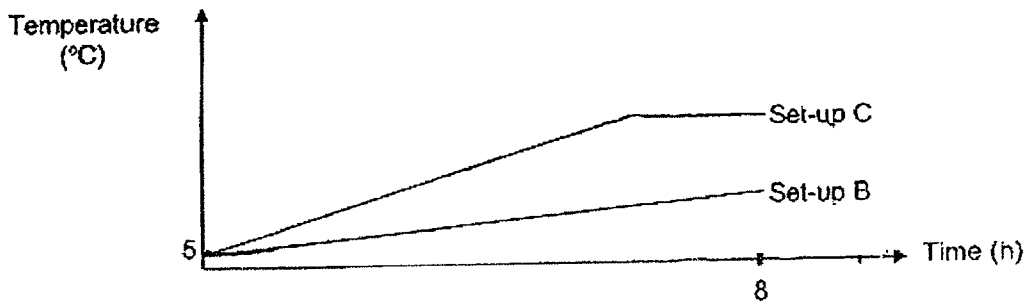

- (a) Draw a line in the graph above to show the change in the temperature of the cold water in set-up A over eight hours. [1]
- (b) Compare the rate of heat gain between the water in set-up B and set-up C. [1]

- (c) Which material, X or Y, is more suitable for making a container to keep food warm for a longer period of time? Give a reason. [1]

- (d) What is the purpose of the control set-up? [1]

(Go on to the next page)

SCORE	
	4

41. Sally set up an experiment to find out how the amount of carbon dioxide affects the rate of photosynthesis in an aquatic plant as shown.

She added a spoonful of baking soda to the water in the test tube to increase the amount of dissolved carbon dioxide in the water.

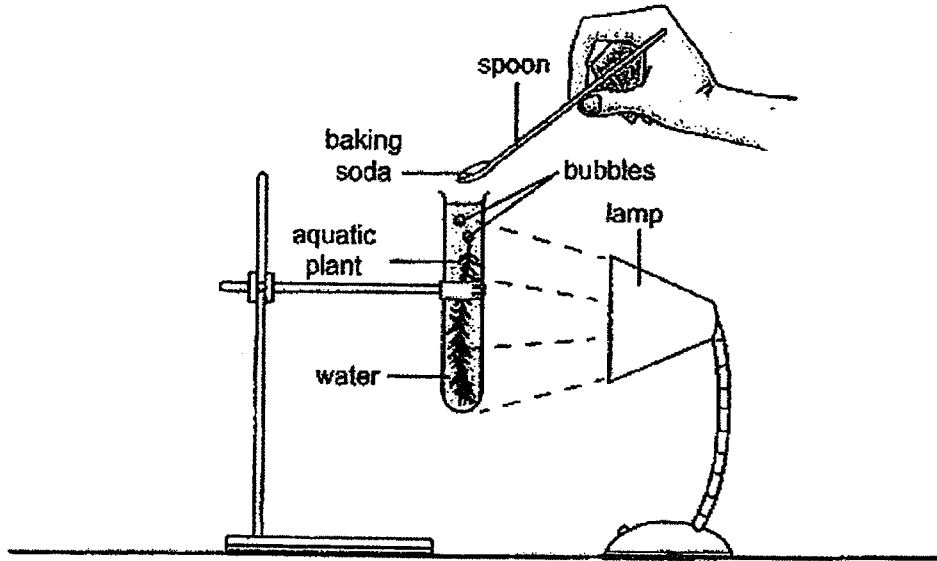

After adding the baking soda, she counted the number of bubbles produced by the aquatic plant in five minutes. She repeated the experiment by adding different number of spoonfuls of baking soda to the water and recorded the results in the table.

Number of spoonfuls of baking soda added to the water	1	2	3	4	5	6	7
Number of bubbles produced by the aquatic plant	2	3	5	8	12	12	12

- (a) What is the relationship between the number of spoonfuls of baking soda added to the water and the number of bubbles produced by the aquatic plant? [2]

---



---



---

- (b) Sally kept the distance between the lamp and the aquatic plant the same throughout the experiment. Explain why this ensures a fair test. [1]

---



---

End of Paper

SCORE	3
-------	---



SCHOOL : ANGLO-CHINESE SCHOOL (JUNIOR)  
 LEVEL : PRIMARY 5  
 SUBJECT : SCIENCE  
 PAPER : 2022 SA2

**BOOKLET A**

Q1	Q2	Q3	Q4	Q5	Q6	Q7	Q8	Q9	Q10
2	2	1	4	2	4	2	1	2	4
Q11	Q12	Q13	Q14	Q15	Q16	Q17	Q18	Q19	Q20
4	2	1	4	3	1	2	3	2	2
Q21	Q22	Q23	Q24	Q25	Q26	Q27	Q28		
1	3	4	3	4	3	4	2		

**BOOKLET B**

Q29a)	Water has no definite shape.
Q29b)	The air spaces between the marbles in beaker B are bigger compared to the air spaces between the sand particles in beaker A. Thus, more water fill up the bigger air spaces in beaker B and the water level in beaker B is lower than that of beaker A.
Q30a)	To find out how the number of structure X on the fruit affects the distance travelled by the fruit.
Q30b)	The young plant would not need to compete with its parent plant for sunlight, water, nutrients and space.
Q30c)	Type of fruit Number of structure X Height that the fruit is dropped
Q31a)	Pollination is the transfer of pollen grains from the anther to the stigma.
Q31b)	A
Q31c)	When part C has been cut and tied, the sperms produced by A are unable to travel up part C to be released through B.
Q32a)	Boiling occurs at a fixed temperature but evaporation occurs at any temperature.
Q32b)	Water droplets
Q32c)	Use a cooler tin tray / tin tray with a lower temperature.
Q33a)	Solid, liquid, gas
Q33b)	Suggestion: Use a fan to blow at the water in the cup. Explanation: The wind from the fan would increase the rate of evaporation of water in the cup.
Q33c)	Warm water vapour exhaled by Hannah came into contact with the cooler surrounding air, lost heat and condensed into water droplets which appeared as white 'mist'.
Q34a)	There are more coils of wires around iron bar P than Q. When both switches were closed at the same time, iron bar P became a stronger electromagnet / had more magnetic strength than Q. Thus, the steel nail would be attracted to iron bar P more than Q and moved towards iron bar P.
Q34b)	When the switch is closed, the circuit is a closed circuit. The electromagnet would be magnetised to attract the metal pieces from the sand and the crane would bring it to collection point W. When the crane reaches collection point W, the switch would be opened to form an open circuit. The electromagnet would be demagnetized and not attract the metal pieces anymore, allowing the metal pieces to drop at collection point W.

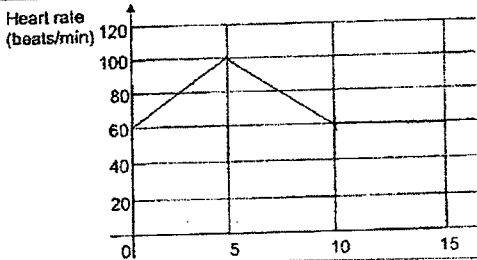
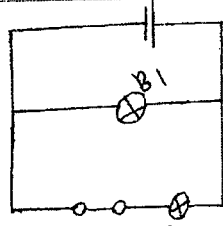
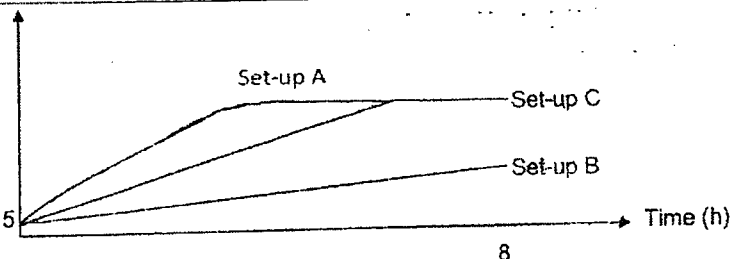
Q35a)	Digestion is the process of breaking down food into simpler substances.
Q35b)	(i) P, R, S (ii) T
Q35c)	Digested food would be absorbed into the blood through the walls of part S.
Q36a)	X: Lungs Y: Gills
Q36b)	There would be increased surface area of contact between the blood and oxygen to increase the rate of absorption of oxygen.
Q36c)	Air in the surrounding enters the nose and into the lungs where oxygen is absorbed into the blood.
Q37a)	When Jack's running speed increases, his body needs more energy. His heart would pump blood faster to transport more oxygen and digested food to other parts of his body for a faster rate of respiration to release more energy.
Q37b)	 <p>Heart rate (beats/min)</p> <p>120 100 80 60 40 20 0</p> <p>0 5 10 15</p>
Q38a)	They are arranged in series.
Q38b)	If one bulb fuses, the other bulb would not light up.
Q38c)	 <p>B1</p> <p>B2</p> <p>(B1 and B2 must be arranged in parallel)</p>
Q39a)	Circle the arrow pointing towards the Sun.
Q39b)	Light travels in a straight line. Light can be reflected.
Q39c)	Light does not occupy space. Light has no mass.
Q40a)	 <p>Temperature (°C)</p> <p>5</p> <p>8</p> <p>Time (h)</p> <p>Set-up A</p> <p>Set-up C</p> <p>Set-up B</p>
Q40b)	The rate of heat gain in set-up C is faster than in set-up B
Q40c)	X. Since the water in Set-up B gains heat slower than Set-up C, X is a poorer conductor of heat than Y and can keep food warm longer.



Q40d)	To compare and confirm that the rate which the water in the containers gain heat is only affected by the type of material that covers the container.
Q41a)	When the number of spoonfuls of baking soda added to the water increases from 1 to 5, the number of bubbles produced by the aquatic plant increases. When the number of baking soda added to the water increases from 5 to 7, the number of bubbles produced by the aquatic plant remains the same.
Q41b)	This is to ensure that only the number of spoonfuls of baking soda added to the water affects the number of bubbles produced by the aquatic plant.

